

F E D C B A

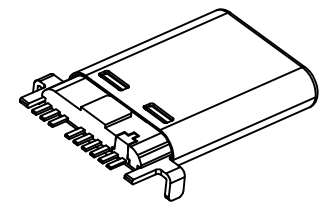

Specification:

- 1.Electrical Characteristics:
 - Contact Current Rating: 3 Amperes Max.
 - Rated Voltage: 30V Max.
 - Dielectric Withstanding Voltage: AC 100V r.m.s.
 - Insulation Resistance: 100 MΩ Minimum.
 - Contact Resistance: 40 mΩ Maximum.
- 2.Environmental:
 - Operating Temperature: -30°C~+85°C.
- 3.Mechanical Characteristics:
 - Insertion Force: 20N MAX.
 - Withdrawal Force: 5~20N.
 - Durability Cycles: 10000 Cycles.

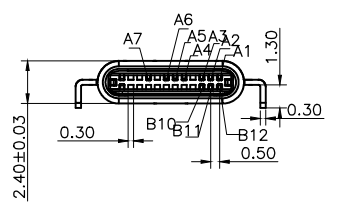
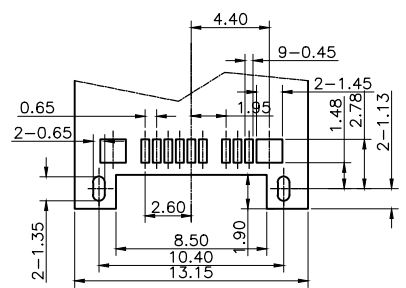
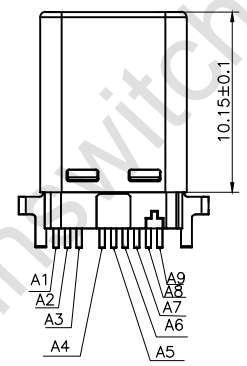
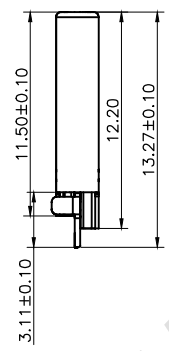
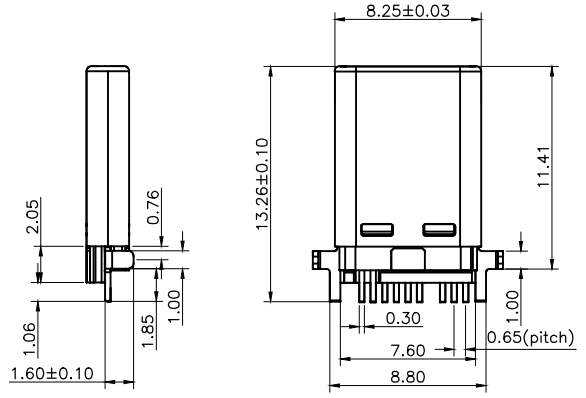

RECOMMENDED P.C.B. LAYOUT
TOLERANCE UNSPECIFIED ±0.05mm

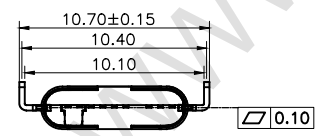

A12	A11	A10	A9	A8	A7	A6	A5		A3	A2	A1	
				VBUS	D-	D+	CC			TX1	TX1	GND
										RX1	RX1	
B1	B2	B3	B4	B5	B6	B7	B8	B9	B10	B11	B12	

5	EMC SPRING	Stainless Steel;T=0.10mm;
4	CONTACT	Copper Alloy;Au1u'';
3	LATCH	Stainless Steel;T=0.3mm;
2	HOUSING	LCP Thermoplastic,UL94V-0;
1	SHELL	Stainless Steel;T=0.15mm;
NO.	NAME	DESCRIPTION

DESIGN	MISS ZENG	SC ALL		未注公差 TOLERANCE	品名:
DRAWIGN	MISS LI	ANIT	MM		连接器
CHECK	Mr. ZENG	SIZE	A4: 210*297		型号:
APPROVAL		VERSION	01		9PIN-常规卡勾带插脚 (拉伸壳)



F E D C B A