

RECOMMEND P.C.B LAYOUT (COMPONENT SIDE)
TOLERANCE FOR PCB LAYOUT IS ±0.05

备注 (NOTE):

1. 电气特性:
1. 接触区: 接触电阻40mΩ Max, 允许10mΩ变化量. 测试条件: 20mv, 100mA下测量.
 2. 接触电流: 3A最大 VBUS和GND引脚; 其他引脚为0.25A.
 3. 额定电压: 5V.
 4. 耐电电压: 100VAC.
 5. 绝缘电阻: 至少100兆欧.
2. 机械性能:
3. 1. 插入力: 0.5-2.0Kg
 3. 2. 拔出力: 0.6-2.04Kg
 3. 3. 插拔次数: 10000次.
 4. 可焊性: 温度210-230℃, 时间10秒.
 5. 工作环境: -20℃ to +85℃.

USB TYPE C PIN ASSIGNMENTS

PIN NUMBER	SIGNAL NAME	PIN NUMBER	SIGNAL NAME
		B12	GND
		B9	VBUS
A5	CC1		
		B5	CC2
A9	VBUS		
A12	GND		

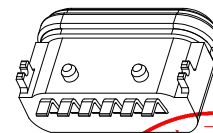
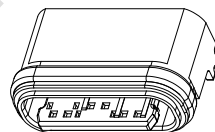
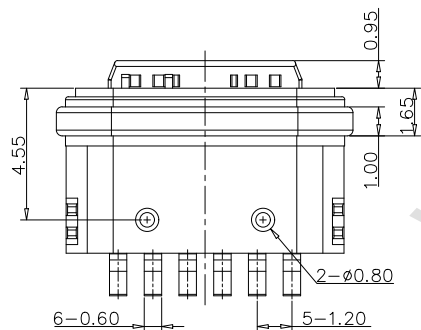
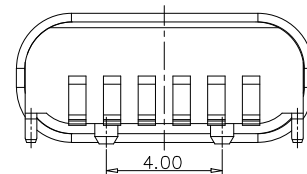
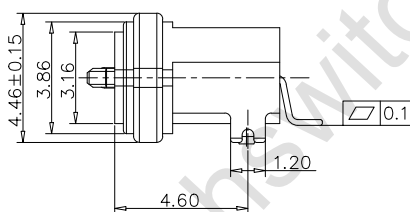
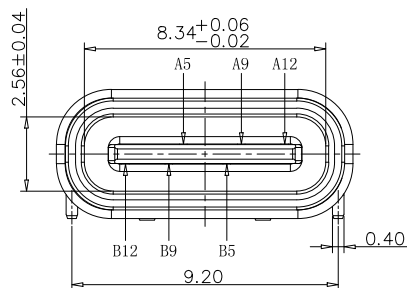

TABLE:

NO	PART	QTY	Material
1	SHELL	1	ZINC ALLOY, NI30u" Min PLATED
2	CONTACT	6	C2680, TIN80u"/Au1u"/NI30u" PLATED
3	1MD HOUSING	1	HIGH TEMPERATURE RESISTANT PLASTIC BLACK UL94 V-0
4	WATERPROOF RING	1	SILICONE UL94 V-0 BLACK

DESIGN	MISS ZENG	SC ALL			TOLERANCE	ANGLES	品名: TYPE-C连接器 型号: TYPE-C 6P 板上防水母座 L=6.65mm
DRAWING	MISS LI	ANIT	mm				
CHECK	Mr. ZENG	SIZE	A4 : 210*297				
APPROVAL		VERSION	01				



东莞市航宏电子科技有限公司
Dongguan Hanghong Electronics Co., Ltd.

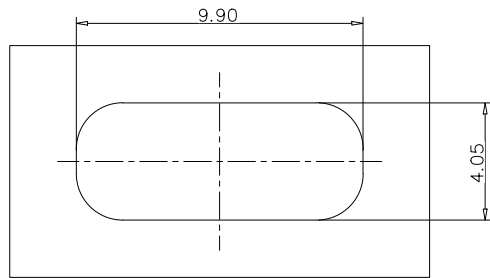

密封开孔参考尺寸(只供参考)
 组装外壳时需要打环保润滑油

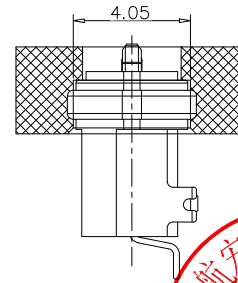
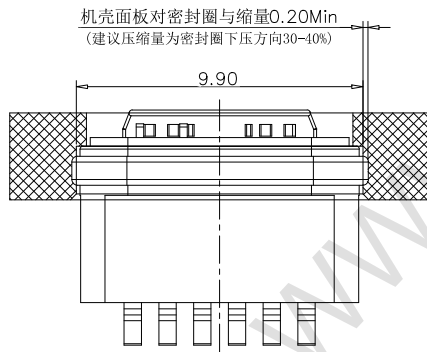

DESIGN	MISS ZENG	SC ALL			TOLERANCE	ANGLES
DRAWIGN	MISS LI	ANIT	mm			
CHECK	Mr. ZENG	SIZE	A4 : 210*297			
APPROVAL		VERSION	01			

品名：TYPE-C连接器
 型号：TYPE-C 6P 板上防水母座
 L=6.65mm



东莞市航宏电子科技有限公司
 Dongguan Hanghong Electronics Co., Ltd.